



Société Nationale de
Certification et d'Homologation
Société à responsabilité limitée







October 14th, 2010

STATEMENT

We confirm, that the following replacement silencer type 4588, produced by SITO Gruppo Industriale S.p.A. (S.G.I.), is complying with

- the EC-Directive 97/24/EC Chapter 9 regarding permissible sound level and exhaust system

An EC type approval number has been granted by the luxembourgian Ministry for Sustainable Development and Infrastructure, department of Transport, for the following version of the above mentioned replacement silencer type:

Silencer Version	Drawing No.	Type approval number	Vehicle type	Vehicle Model
4486	4588	SGI  0459 	C21100 – C210 – C21000 – C220 – C22000 – C22100 – C041 – C18	PIAGGIO NRG mc2 (liquid)
4486	4588	SGI  0459 	C21100 – C210 – C21000 – C220 – C22000 – C041 – C18	PIAGGIO NRG mc2 (Air)
4486	4588	SGI  0459 	AL1BE2 - AL Vers.E2 Var.1A	DERBI ATLANTIS 50



Gilles AST
Expert Technique

Adresse:
BP 23
L-5201 Sandweiler

Siège social:
11, route de Luxembourg
L-5230 Sandweiler

Capital social: 3.500.000 €
R.C. B 27180
N° TVA: LU 13770825

Tél.: (+352) 35 72 14 - 250
Fax: (+352) 35 72 14 - 244
E-mail: info@snch.lu
Home page: www.snch.lu



9933310

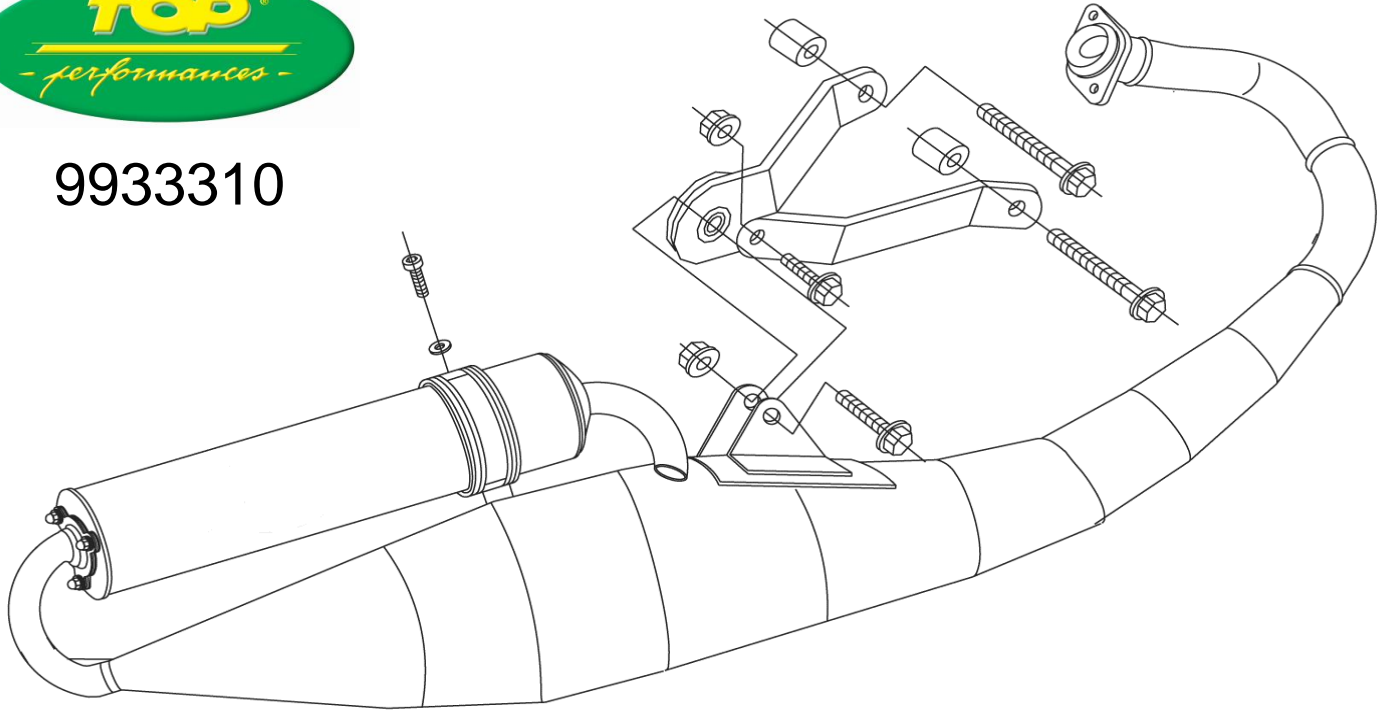

RULLI E MOLLE - ROLLERS AND SPRINGS - MASSELOTTES ET RESSORTS - ROLLEN UND FEDERN - RODILLOS Y MUELLES

RULLI: (art. 4659 – gr 5.3 per la versione ad aria e art. 4659 - gr. 6,0 per la versione ad acqua
MOLLE (PIAGGIO SOFT BLU)

ROLLERS: (art 4659 – 5.3 g. for the air-cooled version, or art 4659 – 6,0 g. for the water-cooled version)

SPRINGS: (PIAGGIO SOFT BLU)

MASSELOTTES: (ref. 4659 - 5,3 grammes pour la version "air" ou ref. 4659 - 6,0 grammes pour la version "liquide") **RESSORTS:** :
(PIAGGIO SOFT BLEU)

RODILLOS: (art. 4659 – gr. 5.3 para la versión de aire en el art. 4659-gr. 6,0 para la versión de agua)

MUELLES: (PIAGGIO SOFT AZUL)

ROLLEN: (Art. 4659 - gr. 5,3 für die luftgekühlte Ausführung und Art. 4659- gr. 6,0 für die wassergekühlte Ausführung) **FEDERN:**
(PIAGGIO SOFT BLEU)

**DISEGNO TECNICO RULLI E MOLLE - TECHNICAL DRAWING ROLLERS AND SPRINGS
 CROQUIS TECHNIQUE MASSELOTTES ET RESSORTS - TECHNISCHE ZEICHNUNG ROLLEN UND FEDERN
 DISEÑO TÉCNICO RODILLOS Y MUELLES**

FIGURA 1



FIGURA 2



MOLLE DA SOSTITUIRE - SPRINGS TO BE REPLACED
 RESSORTS À REMPLACER - ZU ERSETZENDE FEDER
 MUELLES PARA SUSTITUCIÓN

FIGURA 3

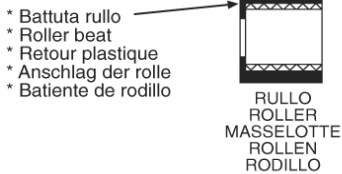
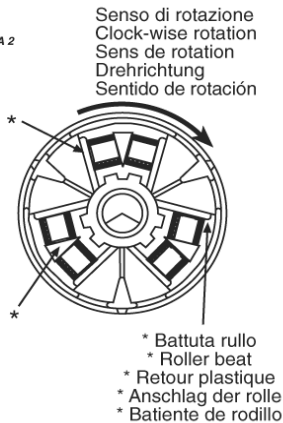
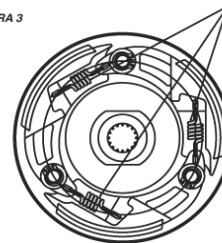

FIGURA 4

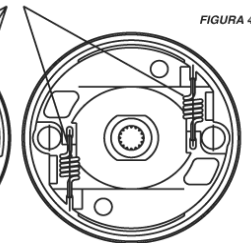

VISTA DAL LATO INTERNO - VIEW FROM THE INNER SIDE
 VUE DE L'INTERIEUR - ANSICHT VON INNENSEITE
 VISTA DESDE EL LADO INTERIOR